

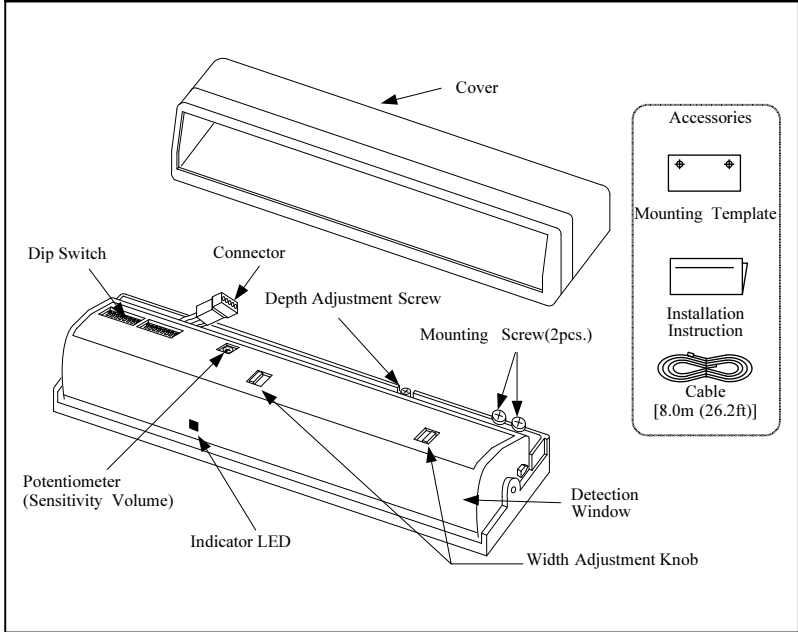

English

## 1. DESCRIPTION



## 4. MOUNTING PRECAUTIONS

<p>Mounting height is 4.7m (15.4ft) or lower.</p>	<p>Mount within 50mm (1.97") from the bottom of the door engine cover.</p>	<p>Ensure there are no moving objects in the detection zone.</p>	<p>Ensure no condensation gets onto the sensor.</p>
<p>If the sensor is exposed to excessive rain install with a Hotron weather cover.</p>	<p>If possible, ensure no accumulation of snow or water on the floor.</p>	<p>Ensure the minimum of reflected sunlight from the floor.</p>	<p>Use different frequency settings for sensors in close proximity.</p>

To maximize the effectiveness of doorway detection, install the HR400-IND outside and inside as shown below.

## 6. MOUNTING & WIRING INFORMATION

**WARNING** Drilling may cause electric shock. Be careful of hidden wires inside the door engine cover.

- Attach the mounting template with its bottom edge parallel to the same position as the bottom edge of the engine cover.
- Drill holes for mounting [3.5mm (0.14")  $\phi$ ] and for wiring [10mm (0.39")  $\phi$ ].
- Remove the cover from the unit.
- Fasten the unit with 2 mounting screws.
- Connect wire.
- House connectors in the receptacle.
- Replace Cover.

Connector of the unit. Wiring Cable

Red & Black (Power)  
White (Common)  
Yellow (N.O.)  
Green (N.C.)

**WARNING** Disregarding this symbol may result in serious injury or death.

**CAUTION** Disregarding this symbol may result in injury or damage to equipment.

**Note** Special attention is required when this symbol is shown.

## 2. DIMENSIONS

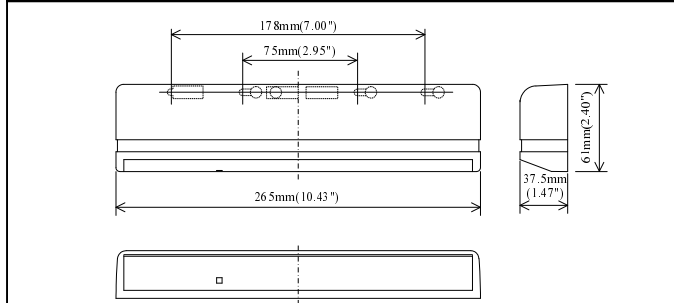

## 3. LED INDICATORS

Green Standby.  
Green blinking Doorway Learning (When dip switch (Y) 8 is ON).  
Red Inner Rows Detecting.  
Blue Outer Rows Detecting.  
Orange Detection row "ROW1"/"ROW2" when "Doorway Learn" is turned ON is detecting door movement.  
Orange blinking Indicates a change of dip switch settings or sensitivity volume.  
Green/Red blinking Internal Sensor Error.

**Note:** Inner rows refer to Rows 1,2,3 when Doorway Learn is turned "ON" and rows 1,2 when Doorway Learn is turned "OFF".  
Outer rows refer to Rows 4,5 when Doorway Learn is turned "ON" and rows 3,4,5 when Doorway Learn is turned "OFF".

## 5. TECHNICAL SPECIFICATIONS

Model Name	HR400-IND
Detection Method	Active Infrared Reflection
Supply Voltage	AC/DC 12 to 24 [V] $\pm$ 10% 50/60Hz
Installation Height	4.7[m] (15.4 [ft]) MAX
Power Consumption	AC12V-2.5 [VA] (Max) AC24V-2.5 [VA] (Max) DC12V-140 [mA] (Max) DC24V-65 [mA] (Max)
Output Holding Time	Approx. 0.5s
Response Time	0.1s
Presence Timer	2s, 60s, 10m or $\infty$
Output	Form 1C Relay DC 50 [V], 0.1[A] Resistor Load
Operating Temperature	-20 to +60 [Deg.C], (-4 to 140 Deg.F)
Operating Humidity	Below 80%
IP Rate	IP54 (With Base)
Weight	0.64 [lb.](0.29[kg])
Color	Black, Silver
Accessories	Cable {8.0[m] (26.2[ft])}, Mounting Template, Installation Instruction

Notice: Specification may be changed without prior notice.

## 7. DIP SWITCH SETTINGS

Function	Dip Switch (X)	Description	Possible Setting Options
Presence Timer	$\star$ 2s 1 2	The sensor will detect a stationary object for the period of time of the presence timer set. Applies to Rows 1,2 when Doorway Learn is "OFF" and Rows 1,2,3 when Doorway Learn in "ON".	$\star$ 2s 1 2    60s 1 2    10m 1 2 $\infty$ 1 2
Frequency	$\star$ A 3 4	When more than two sensors are installed in close proximity to each other select different frequency settings for each sensor to prevent cross interference.	$\star$ A 3 4    B 3 4    C 3 4    D 3 4
Detection Rows	$\star$ R5 5 6	The number of the rows of detection can be selected by setting to 5, 4, 3, 2 depending on detection area requirements.	$\star$ R5 5 6    5 Rows ON R4 5 6    4 Rows ON R3 5 6    3 Rows ON R2 5 6    2 Rows ON
Monitor Mode	$\star$ Normal 7 8	Set to Snow1, Snow2 or Snow3 in case false door activations occur from blowing snow, leaves or rubbish in the door close area. <b>Note</b> Snow1(Weak) / Snow2(Middle) / Snow3(Strong)	$\star$ Normal 7 8    Snow1 7 8    Snow2 7 8    Snow3 7 8
Function	Dip Switch (Y)	Description	Possible Setting Options
Detection Rows: Left Side	$\star$ R6 1 2	Left side detection area width can be set to 6, 4 or 2 rows.	$\star$ R6 1 2    6 Rows ON R4 1 2    4 Rows ON R2 1 2    2 Rows ON
Detection Rows: Right Side	$\star$ R6 3 4	Right side detection area width can be set to 6, 4 or 2 rows.	$\star$ R6 3 4    6 Rows ON R4 3 4    4 Rows ON R2 3 4    2 Rows ON
Installation Height Settings	$\star$ 2.0m(6.6ft)~2.5m(8.2ft) 5 6	Set to installation height required. <b>Note</b> After setting the Installation Height, refer to (10. VERIFICATION OF OPERATION) to set the correct corresponding sensor sensitivity.	$\star$ 2.0m(6.6ft)~2.5m(8.2ft) 5 6    2.5m(8.2ft)~3.0m(9.8ft) 5 6    3.0m(9.8ft)~3.5m(11.5ft) 5 6    3.5m(11.5ft)~4.7m(15.4ft) 5 6
Direction Detection	$\star$ OFF 7	When set to ON, pedestrians moving away from the sensor will not be detected. <b>Note</b> For pedestrian's safety when "Doorway Learn" is set to ON the 1 <sup>st</sup> and 2 <sup>nd</sup> row of detection will detect pedestrians regardless of direction of movement.	$\star$ OFF 7    ON 7
Doorway Learn	$\star$ OFF 8	"Doorway Learn" allows the 1 <sup>st</sup> row of detection to be focused inside the door close area without detecting the door movement. <b>Note</b> When "Doorway Learn" is turned ON, the sensitivity level of the 1 <sup>st</sup> row of detection is at maximum only when the outer rows of detection are activated.	$\star$ OFF 8    ON 8

## 8. APPLYING POWER AND THE "DOORWAY LEARN" SETTING

**"Doorway Learn" is OFF** (Dip Switch Y 8 OFF)  
Ref section 7, Dip Switch Settings.

**"Doorway Learn" is ON** (Dip Switch Y 8 ON)  
Ref section 7, Dip Switch Settings.

<p>Upon power ON, the solid Green LED turns on indicating that the sensor is in a standby mode and ready to detect.</p>	<p>Upon power ON, the Red LED indicates a door open relay output to begin the "Doorway Learn" process.</p>	<p>Green LED blinks for 37s (MAX.) while the "Doorway Learn" process is carried out. Door opens/closes.</p>	<p>After the "Doorway Learn" process is completed, sensor is in a standby mode.</p>
---	--	---	---

**Presence Detection:** It takes 10s after sensor power up for presence detection to be initiated. If before 10s has elapsed someone walks into the detection area, all rows of detection on HR400-IND switch from motion detection to presence detection 5s after the person leaves the detection area.

**Presence Detection:** During the "Doorway Learn" process the HR400-IND switches from motion to presence detection 10s after power ON. The inner "Doorway Learn" row of detection will switch from motion to presence detection after the "Doorway Learn" process is completed.

**"Doorway Learn" Failure & Recovery:** If a person enters the detection area during the "Doorway Learn" process it may not be successfully completed. In this case the sensor will carry out the "Doorway Learn" process on door activation caused by a person in order to create an accurate image of opening and closing of the door.

**Note** When "Doorway Learn" is turned ON, the sensitivity level of the inner row of detection is at maximum only when the outer rows of detection are activated.

**General Caution:**  
When carrying out the following work, turn off sensor power.  
※ When the floor condition is changed by placing a mat on the floor etc.  
※ When the detection area pattern or sensor sensitivity is adjusted.

**CAUTION**  
If you change dip switch settings or sensitivity volume, the sensor will reset itself. During resetting, an orange LED will blink.

## 9. DETECTION AREA WIDTH AND DEPTH ADJUSTMENT

Detection Area

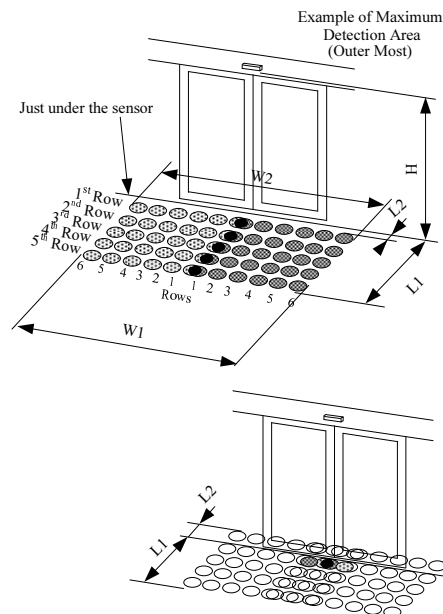

Unit: mm(inches)

H	Outermost detection area				Innermost detection area			
	W1	W2	L1	L2	W1	W2	L1	L2
2000 (78.7")	2590 (102.0")	2450 (94.5")	1860 (73.2")	100 (3.9")	2180 (85.8")	2360 (92.9")	1130 (44.4")	-500 (-19.7")
2500 (98.4")	3230 (127.2")	3060 (120.5")	2330 (91.7")	100 (3.9")	2720 (107.1")	2950 (116.1")	1420 (55.9")	-620 (-24.4")
3000 (118.1")	3880 (152.8")	3680 (144.9")	2790 (109.8")	100 (3.9")	3270 (128.7")	3540 (139.4")	1700 (66.9")	-750 (-29.5")
3500 (137.8")	4530 (178.4")	4290 (168.9")	3260 (128.4")	100 (3.9")	3810 (150.0")	4130 (162.6")	1980 (78.0")	-870 (-34.3")
4000 (157.5")	5180 (203.9")	4900 (192.9")	3720 (146.5")	100 (3.9")	4360 (171.7")	4720 (185.8")	2260 (89.0")	-1000 (-39.4")
4700 (185.1")	6080 (239.4")	5760 (226.8")	4370 (172.1")	100 (3.9")	5120 (201.6")	5550 (218.6")	2670 (105.2")	-1170 (-46.1")

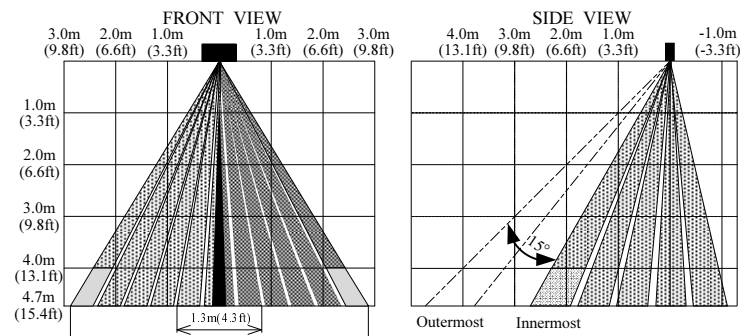

If mounting height is over 4.0m(13.1ft), set to R4 or less. See section 7, Detection Rows right side and Detection Rows left side.

If mounting height is over 4.0m(13.1ft), set to R4 or less. See section 7, Detection Rows.

How to adjust Detection Depth

How to adjust Detection Width

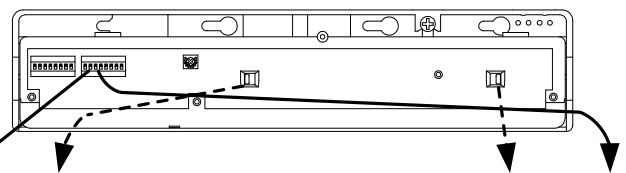
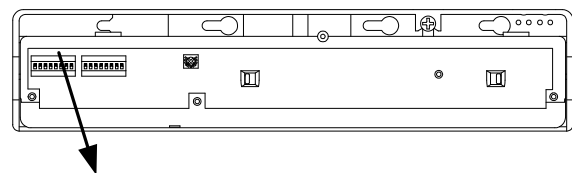

Dip Switch 5 & 6

Dip Switch 1 & 2, Width Adjustment Knob, Dip Switch 3 & 4

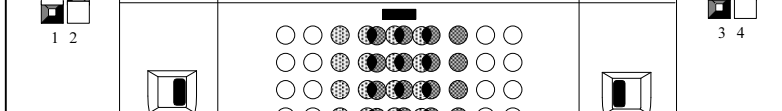
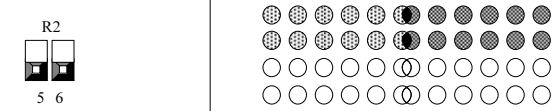
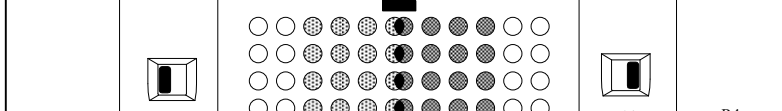
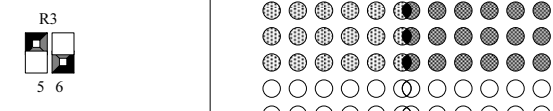
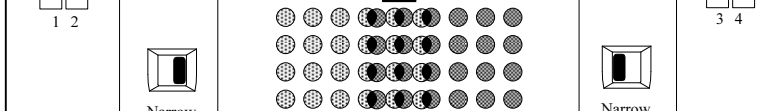
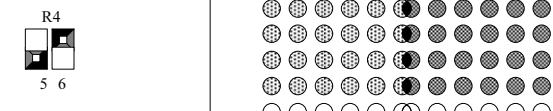
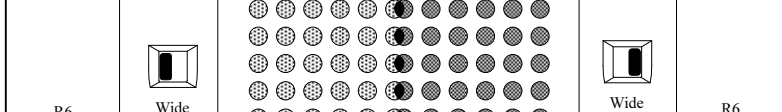
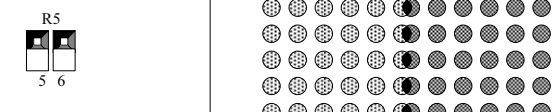

Depth Adjustment Screw

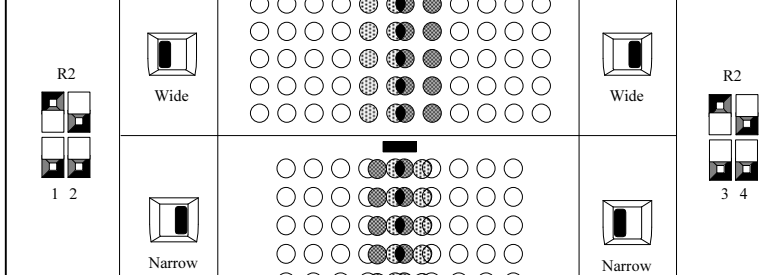
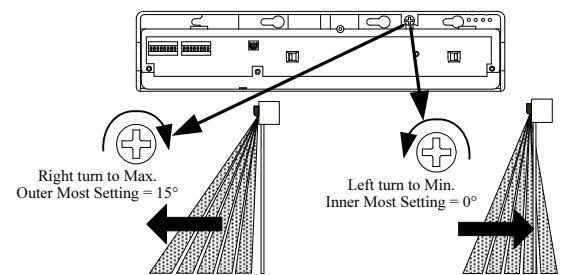

The above illustrated detection areas represent the actual position of infrared beams. The actual detection area observed will vary depending on sensor installation environment, object(s) been detected and sensor setting.

## 10. VERIFICATION OF OPERATION

After installation is completed "walk test" the sensor detection area. If the detection area is not as expected adjust the detection area referring to section 9 or increase the rows of detection using Dip switch 5 & 6, Dip switch 1 & 2 or Dip switch 3 & 4. If the detection area is still not as expected then the sensor sensitivity should be increased by turning the potentiometer clockwise. When the sensor detects even though there is nothing in the detection area the sensor sensitivity should be decreased by turning the potentiometer in the anti-clockwise direction.

Standard of sensitivity volume setting depending on Mounting Height.

Height Setting	Setting Standard
2.0m(6.6ft)-2.5m(8.2ft)	4
2.5m(8.2ft)-3.0m(9.8ft)	5
3.0m(9.8ft)-3.5m(11.5ft)	6
3.5m(11.5ft)-4.7m(15.4ft)	7

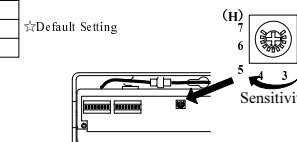

## 11. SELF-MONITORING

When the sensor has the internal sensor error, the door will remain opened and the Green / Red LED will blink alternately.

Relay output waveform in case of abnormal operation LED Indicators blinks Green and Red.

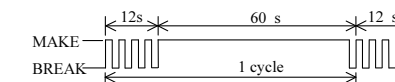

## 12. TROUBLESHOOTING

Problem	LED Status	Possible Cause	Solution
Door does not open when a person enters the detection area.	OFF	Sensor Connector not connected correctly.	Tighten or reconnect the connector.
		Incorrect power supply voltage.	Apply proper voltage to the sensor. (AC/DC 12-24V)
		Incorrect sensor wiring.	Double check sensor wiring.
Door opens and closes for no apparent reason (Ghosting).	Door Opens RED/BLUE Door Closes GREEN	Object moving in the detection area.	Remove the moving object from detection area.
		Sensitivity too high for the installation environment.	Reduce the sensor sensitivity.
		Dust, frost or water droplet on the sensor lens.	Wipe the sensor lens clean and install a weather cover if necessary.
		Detection pattern is too far from the door, detecting people passing by.	Adjust the detection pattern.
		Detection area overlaps with that of another sensor.	Ensure different frequency setting for each sensor.
When Door opens or closes, LED ORANGE.	ORANGE	Detection of falling snow, insects, leaves etc.	Adjust the monitor mode.
		Detection row "ROW1" ("ROW2" when "Doorway Learn" is turned ON) is focused too close to the door.	Adjust detection depth of rows away from the door.
		Detection area changed, while infinity presence timer setting is in use.	Re-power the sensor or change the presence timer settings to 60 secs.
Door opens and remains in the open position.	RED/BLUE	Incorrect sensor wiring.	Double check sensor wiring.
		Reflected signal saturation.	Remove highly reflective objects from the detection area, or lower the sensor sensitivity.
	GREEN/RED FLASH	Internal sensor error.	Replace the sensor.

< Disclaimer > The manufacturer cannot be held responsible for below.

- Misinterpretation of the installation instructions, wrong connection, sensor modification and inappropriate installation.
- Damage caused by inappropriate transportation.
- Accidents or damages caused by fire, pollution, abnormal voltage, earthquake, thunderstorm, wind, floods and other acts of providence.
- Losses of business profits, business interruptions, business information losses and other financial losses caused by using the sensor or malfunction of the sensor.
- Amount of compensation beyond selling price in all cases.

**HOTRON HOTRON CO., LTD.**

Manufacturer  
HOTRON CO.,LTD.  
1-11-26 Hyakunin-Cho, Shinjuku-Ku, Tokyo, Japan  
Phone: +81-(0)3-5330-9221  
Fax: +81-(0)3-5330-9222  
URL: <http://www.hotron.com>